



FEATURES

- Stainless steel
- Protection class IP67

SPECIFICATIONS

Max. capacity	kg	500, 1tf, 2tf, 5tf
Rated output	mV/V	2.0 ± 0.002
Zero balance	mV/V	0 ± 0.02
Combined error	%	0.03
Repeatability	%	0.01
Creep for 30min.	%	0.03
Temperature effect on		
Zero Value	%/10°C	0.03
Output value	%/10°C	0.014
Excitation		
Recommended	V	10
Maximum	V	15
Resistance		
Input	Ω	400 ± 25
Output	Ω	350 ± 3.5
Insulation	MΩ	> 2,000
Compensated temperature range	°C	-10 to +40
Operating temperature range	°C	-30 to +80

DIMENSIONS

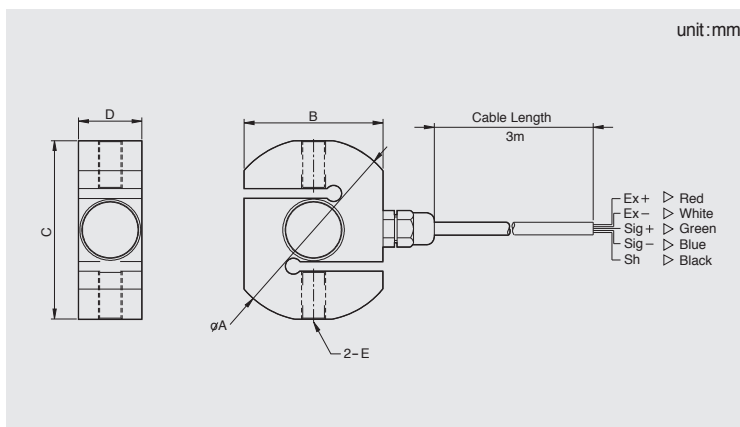

Material

Stainless steel

Cable

Braided shield 4-wire round cable with Urethane-jacket

Model	Capacity	A	B	C	D	E
SBS-500L	500kgf	92	70	90	32	M12 × 1.75
SBS-1	1tf	92	70	90	32	M18 × 1.5
SBS-2	2tf					
SBS-5	5tf	130	100	120	45	M24 × 2.0